

## Experiments with Lithium Limiter on T-11M Tokamak and Perspectives of the Lithium Capillary-Pore System Application in Fusion

S.V. Mirnov 1), E.A. Azizov 1), V.A. Evtikhin 2), V.B. Lazarev 1), I.E. Lyublinski 2),  
A.V. Vertkov 2)

1) SSC RF TRINITI, Troitsk, Moscow region, Russia

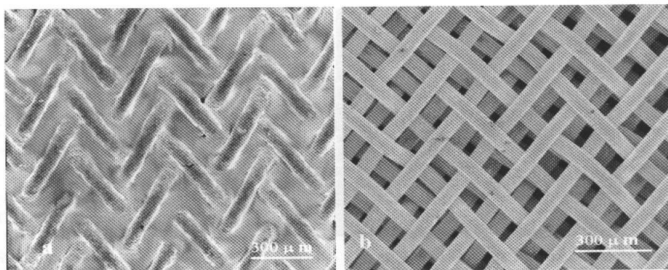
2) FSUE «Red Star» - «Prana-Centre» Co, Moscow, Russia

e-mail contact of main author: [mirnov@triniti.ru](mailto:mirnov@triniti.ru)

**Abstract.** The paper presents the results of two stages of the Li Capillary-Pore System (CPS) researches in T-11M. An ability of capillary forces to confine the liquid Li in (CPS) tokamak limiter during disruption was demonstrated. The Li erosion process and tokamak first wall sorption properties were also investigated. As a next step of program was the development of a new thin (0,6mm) CPS limiter for a steady-state limiter mode achievement. The second stage of T-11M Li-program was experiments with a clean ( $Z_{\text{eff}} \approx 1$ ) deuterium plasma in discharge duration up to 0.3s. The temporal evolution of Li surface temperature was measured during discharge by IR radiometer at different initial limiter temperatures. The neutral Li line emission was measured for estimating the Li influx. The temperature increase of Li erosion was obtained. The radial distribution of radiation losses shown up to 80 % of radiation power from a thin (5cm) plasma layer and only 20% from a plasma core even at Li high influx. The Li emission oscillation and saw-tooth like oscillations of the limiter surface temperature have been detected on the highest level of Li limiter temperature ( $>600^\circ\text{C}$ ).

### 1. Introduction

The application of lithium as a self-recovery and renewable material of tokamak plasma facing components (PFC) has a number of potential advantages in comparison with other materials and, probably, will help to solve the most important problems first wall and divertor plates of the steady-state tokamak-reactor without essential increasing of plasma  $Z_{\text{eff}}$  [1]. However, the temperature of reactor PFC should be higher as lithium melting point. Lithium should be liquid during reactor operation and its use leads to certain problems: 1) liquid metal splashing under the  $J \times B$  forces during MHD instabilities requires a mechanical stabilization of free lithium surface, 2) ion sputtering can be anomalous as result of plasma-lithium interaction, 3) to prevent the thermal emission of lithium should be foreseen the thermal stabilization of lithium surface and heat removal, 4) should be foreseen the tritium removal. The idea to use lithium in tokamaks as PFC was advanced basing on the surface tension forces in capillary channels that may be used to compensate ponder-motive forces [2,3]. These capillary channels (Fig.1) may be realized in the form of so called “capillary-pore systems”(CPS).



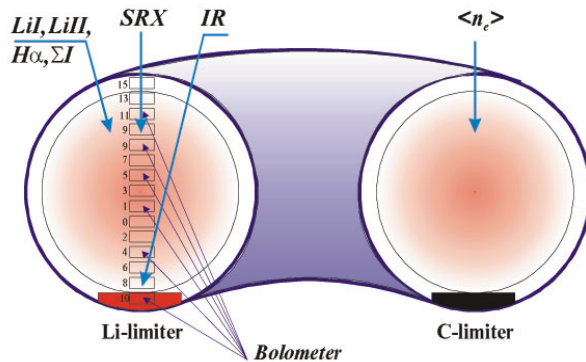
**Fig.1.** Two micro photos of molybdenum wire CPS (wire thickness is equal 100μm) with (left) and without (right) Lithium.

A self-recovery of liquid metal surface by the capillary forces is an intrinsic property of such structures. The lithium rail limiters basing on CPS have been tested in tokamak T-11M (1998-2004, TRINITI ) in plasma conditions similar to SOL- plasma of tokamak-reactor ( $T_e = 10-30\text{eV}$ ,  $n_e \approx 10^{19}\text{m}^{-3}$ ). The compatibility of liquid lithium PFC with tokamak plasma was the main subject of these investigations [4-8]. As

purpose, the first stage of program (1998-2001) was demonstration of capillary forces ability to confine the liquid lithium in porous structure under the  $J \times B$  forces during tokamak ordinary and disruption regimes. As the next step of lithium program in T-11M (2002-2004) was the new limiter development with a thin lithium CPS coating and heat accumulator for achievement of steady-state thermal limiter mode. The solution of this problem means in principal the solution of heat removal problem in reactor.

## 2. Lithium experiments on the T-11M tokamak

The main parameters of T-11M tokamaks are the following:  $R=0.7$  m,  $a=0.2$  m,  $B_t=1$ T, plasma current  $J_p \approx 100$  kA,  $n_e=(2 \div 4) \cdot 10^{19} \text{m}^{-3}$ ,  $T_e(0)=400 \text{eV}$  [8,16,17]. The main experimental dates of lithium erosion and tokamak vessel sorption properties were obtained in the first stage experiments (1998-2001) with the discharge duration 0.1s. The second experimental stage (2002-2003) was performed in T-11M with discharge duration up to 0.3s. Movable (from shot to shot) rail limiter (Fig.2) with lithium CPS defense was inserted into plasma

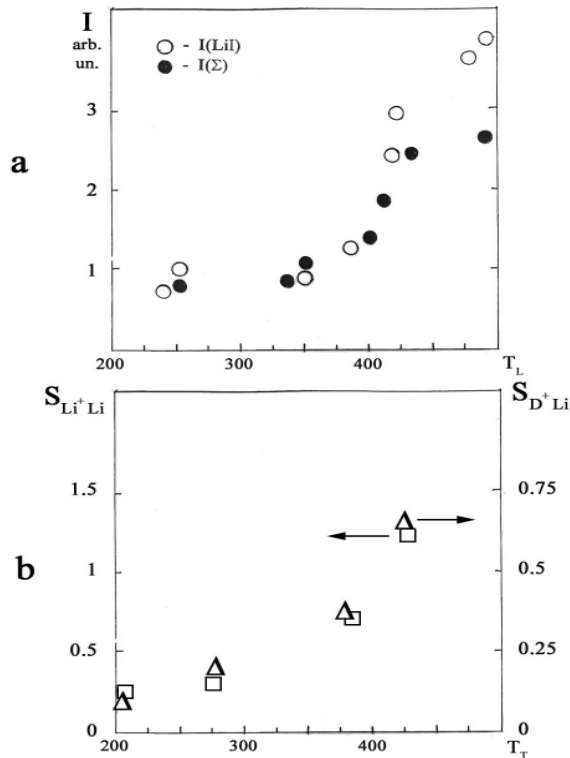


**Fig.2.** Scheme of Li-experiment in T-11M.

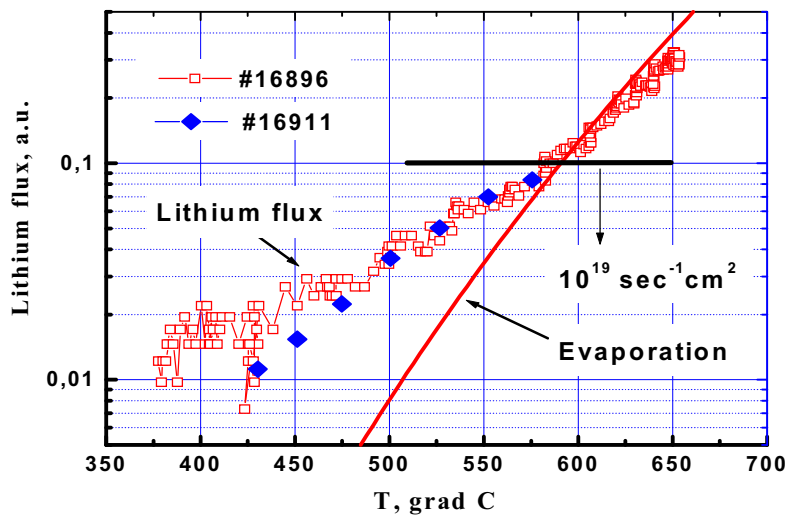
about to 3cm, thus limiting plasma column aperture and determining plasma current ( $q(a)=3-4$ ). The thickness of CPS layer was in the first stage experiments equal 1cm ("massive" CPS) and during second stage equal 0.6-1 mm ("thin" CPS coating). Conventional graphite limiter was placed in the opposite port for comparison with the lithium one. Two fast thermocouples were fitted in lithium limiter close to its surface to measure total energy absorbed by the limiter during discharge. Standard optical diagnostics of LiI, LiII and total visible light  $\Sigma I$  was applied to observe lithium flux into the plasma. Besides, a 15-channel bolometer system was set up and a special infrared diagnostics (IR radiometer [6]) was developed to measure the limiter surface temperature during discharge and to evaluate the deposited power values [10]. Thermal load on limiter surface was about  $10 \text{ MW/m}^2$  in normal discharges and achieved  $100 \div 200 \text{ MW/m}^2$  during disruption. The limiter temperature addition per shot was from 50 to  $750^\circ\text{C}$ . The added heaters incorporated in the limiter structure permitted to control an initial limiter temperature.

More than 3000 plasma shots with hydrogen, deuterium and helium were carried out on the T-11M tokamak and plasma interaction processes with lithium CPS has been studied. The neutral lithium line emission was measured for the lithium influx estimate.

No catastrophic events leading to spontaneous lithium injection in MHD stable discharges within the whole lithium temperature range (from  $20^\circ\text{C}$  to  $600^\circ\text{C}$ ) have been observed in T-11M and it was the most important result of the first step experiments. Lithium and graphite limiters worked roughly similar. Preheating of the lithium limiter gave rise to lithium injection into plasma detected by an increase of lithium lines and total radiation in the vicinity of the limiter. It was shown, that lithium emission slow depends on energy of bombardment ions, but reveals a clear visible dependent from limiter temperature [6,8].



**Fig.3.** Lithium emission as function a limiter temperature[8] and ion sputtering, as function of Li temperature [9].



**Fig. 4.** Measured and calculated fluxes of neutral lithium vs limiter surface temperature.

The estimations of absolute lithium emission has shown that for limiter temperatures  $T_0 < 500^\circ\text{C}$  it remains in the ranges expected for sputtering by  $D^+$  and  $Li^+$  ions with sputtering yield from 0.5 to 1. This correlated with known data on Li-sputtering [9] by ion beams bombardment.

In Fig.3 there are presented the lithium light intensity [8] and sputtering rates [9], as a function of real limiter temperature  $T_L$  and Li target temperature  $T_T$ . The similarity of both curves allows to suppose, that in temperature range  $200\text{-}500^\circ\text{C}$  the main mechanism of Li-limiter erosion have the same physical nature, as liquid Li erosion during ions bombardment.

For limiter temperatures higher than  $T_0 \approx 500^\circ\text{C}$  (Fig.4) Li-evaporation appears as the main channel of lithium emission, which have exponential dependence from  $T_L$

As lithium temperature increased up to  $650^\circ\text{C}$  the bursts of lithium emission and saw teeth like oscillations of the limiter surface temperature have been detected [16]. Obviously, that the best working temperatures for Li PFC should be  $300\text{-}500^\circ\text{C}$ , until Li flux is not very high, but already exists the negative feed back connection between energy flux to PFC and plasma cooling by Li-injection.

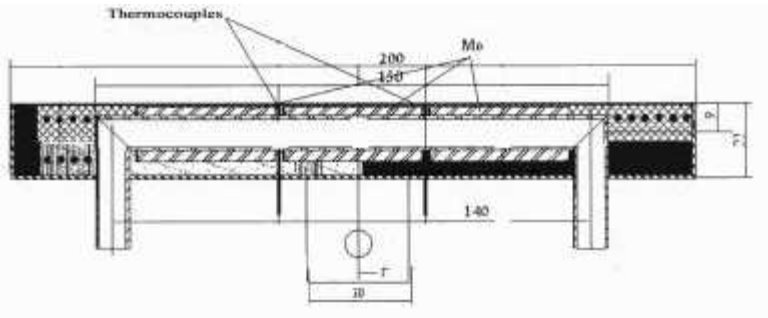
### 3. Disruption resistance of lithium CPS

Disruption resistance of Li CPS was tested in model experiment [7] and in T-11M disruptions. In model experiment the disruption effects have been simulated by plasma accelerator with energy load  $Q = 4\text{-}5 \text{ MJ/m}^2$  and pulse duration  $\tau = 0.2\text{-}0.5 \text{ ms}$ . It was shown that a dense plasma layer, 10-15 mm thickness with  $n_e = 10^{23} \text{ m}^{-3}$ , is formed in front of the target. The major part of the plasma energy ( $\sim 97\text{-}99\%$ ) was absorbed and radiated in this

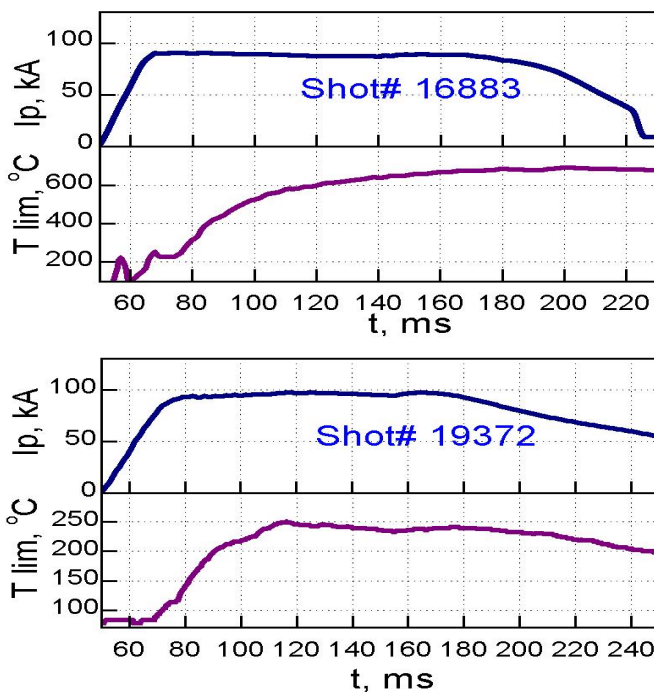
layer, which plays the role of a shielding layer. This result has been confirmed qualitatively in T-11M experiment: only 30-50J of about 0.7 kJ of total plasma energy loss has been found to reach the rail limiter during disruptions. The solid basis of CPS limiter had no damages after more than  $2 \cdot 10^3$  of plasma shots with 5-10% of disruptions. Relatively small amount of lithium was evaporated from the target during test pulses. The reason of main lithium erosion was splashing [9]. We have to note, that Li-splashing didn't have a dramatically consequences for the plasma performance in the next shots of T-11M.

#### 4. Experiments with thin Li-CPS limiter

An idea of thin ( $\delta \approx 1-2\text{mm}$ ) CPS layer coated a traditional cooled backing [8] seems to be one of solutions of CPS cooling problem. The ends of CPS should sink in Li-reservoir so that it works as steady-state Li-wick. Then the main heat flux should go across thin CPS layer to cooled backing and lithium can flow to limiter surface along wick. In Fig.5 is presented the typical schema of thin CPS-limiter. The role of cooled backing plays thick Mo-tube (3mm), which worked as good heat accumulator during 200ms of T-11M typical shot.

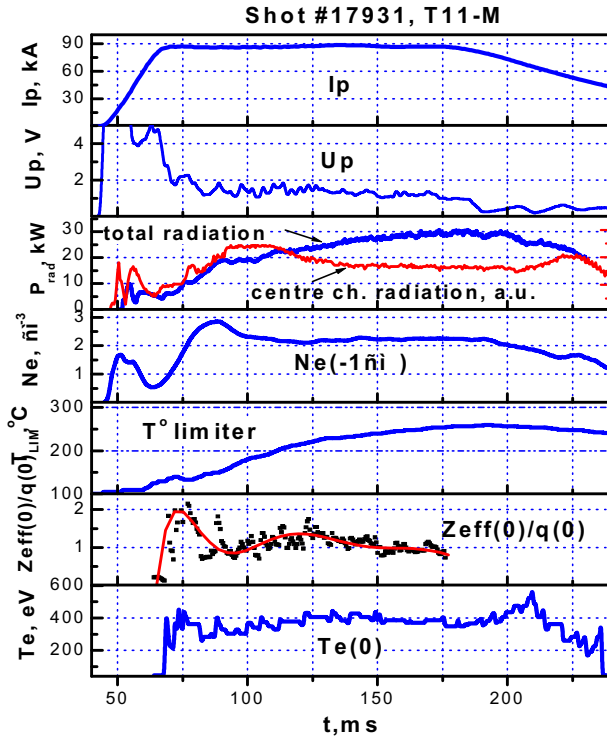


*Fig.5. Scheme of thin CPS-limiter with Mo-accumulator and tube for water cooling.*

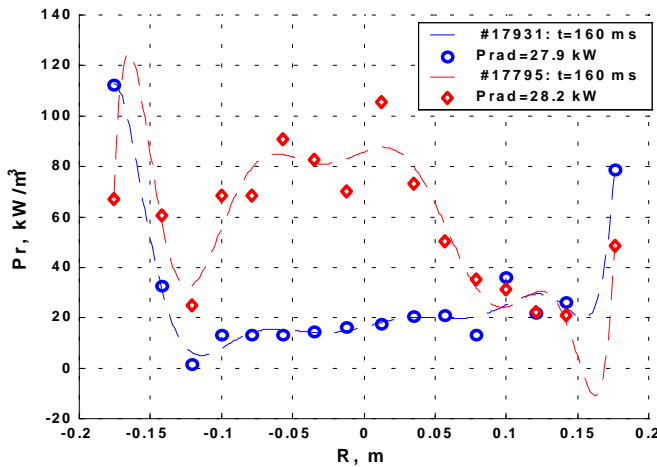


*Fig.6. Two shots: without (#16883) and with (#19372) a good heat contact with backing*

Obviously a critical element of this scheme is heat contact between CPS and backing. To estimate a thin limiter efficiency we made several series of experiments in T-11M. Fig. 6 shows two T-11M shots with different thin limiter design: without heat contact CPS-Mo tube and with good contact. In the first case the surface limiter temperature increases to  $650^{\circ}\text{C}$  and stay almost constant when shot is finished. In the second case the surface heated only to  $200^{\circ}\text{C}$  and slow decreased during shot, probably as result of power load diminish during discharge.



**Fig. 7.** T-11M plasma parameters with a thin CPS (0.6mm) lithium limiter.



**Fig. 8.** The radiative loss profiles at the moment  $t = 160$  ms, the average plasma density  $\langle n_e \rangle \sim 2.2 \cdot 10^{19} \text{m}^{-3}$  for both cases. Diamonds-C limiter, circles-Li limiter.

## 5. Plasma edge instability at high lithium influx

At relatively low starting temperatures of lithium limiter (250...400°C) the radiation of a plasma shell is monotonically increased according to the growth of lithium surface temperature of and related increase of neutral lithium influx into the plasma (Fig.9). The total power of radiative losses grows similarly, since the outer plasma layers give the major contribution (~80%) to the total losses. However, the behaviour qualitatively varies after the transition into the higher temperature range 500...600°C, and oscillations of all plasma parameters observed at the plasma edge (Fig.9,10). Their amplitude increase following the

The shots with thin cooling CPS, when the limiter temperature and main plasma parameters were almost constant, seem as quasi-state discharge with Li-limiter.

One of such typical shot is presented in Fig.7 [16-17], where are shown: total current  $J_p(t)$ , voltage  $U_p(t)$ , total radiation flux from plasma center, mean electron density  $N_e(t)$ , limiter temperature  $T_{lim}(t)$ , parameter  $Z_{eff}(0)/q(0)$  and electron temperature  $T_e(t)$ . The most important feature of such quasi-state shots is constancy of parameter  $Z_{eff}(0)/q(0) \approx 1$ . If we suppose, that  $q(0)$  is equal 1,  $Z_{eff}(0)$  should be close 1 too, that is an evident of very clean plasma in the center of column.

This conclusion is supported by measurements of radiation distribution across plasma column (Fig.9), which shows the very low radiation losses from plasma center during Li-limiter discharge.

It was shown that up to 70 % of radiation losses are radiated in a rather thin plasma surface layer ( $\approx 5\text{cm}$ ) without significant radiation cooling of the core plasma even at lithium high influx. By contrast the high level central radiation was measured in C-limiter shots. We have to note, that the common feature of all discharges with Li limiters and first wall, covered by lithium (T-11M [6,7,8], TFTR [11], CDX-U [10]), was a very low hydrogen recycling coefficient and as result the high gas puffing, which we needed to use quasi-state regimes.

limiter surface temperature, and the latter itself begin to oscillate as well. The period of these oscillations are  $\sim 20$  ms and rise and fall times, 2...3 ms and 15-18 ms respectively at the lithium temperature  $\sim 700^\circ\text{C}$ . The period of these oscillations is more at higher surface temperature. Although the nature of these oscillations is not completely clear, it is possible to assume, that they are caused by the high influx of neutral lithium into the peripheral plasma area resulting to its cooling. The estimated total influx of lithium atoms from the limiter is  $\Gamma \sim 5 \cdot 10^{20} \text{ s}^{-1}$ . Normalizing this value by the area of the outer magnetic surface of a tokamak

T-11M, the average influx density is about  $\Gamma/S \sim 2 \cdot 10^{20} \text{ s}^{-1}/\text{m}^2$ . Very close value for a threshold of transition in a non-stationary mode, or threshold of "ionisation-condensation" instability with formation of MARFE-like region was calculated in [14], where the behaviour of lithium

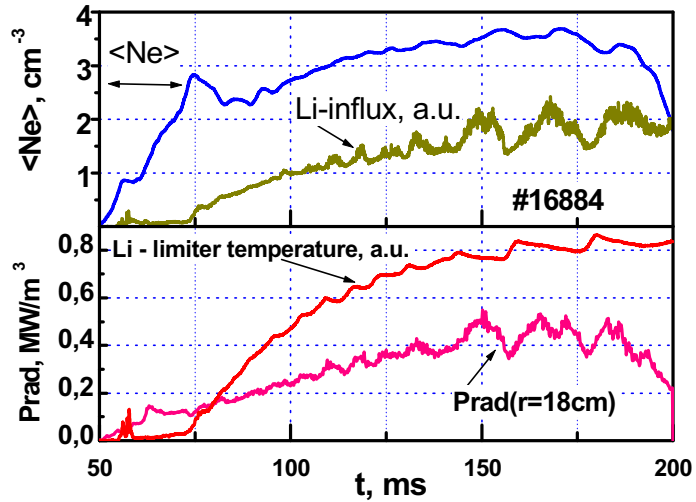
in SOL of the ITER-like "lithium tokamak" with the help of the two-dimensional numerical code was simulated. Both effects observed on the T-11M tokamak with lithium limiter. Namely:

- formation of a screening radiative shell at Li influx level below  $\Gamma/S \sim 2 \cdot 10^{20} \text{ s}^{-1}/\text{m}^2$ ;
- development of "ionisation-condensation" instability at Li influx above this level.

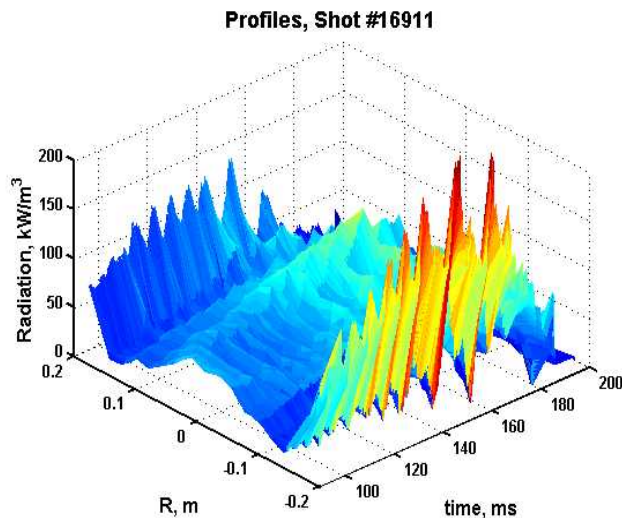
These results are in a some agreement with the behaviour of lithium in the SOL region, predicted in reference [14]. An other significant result is that such high Li influx  $\Gamma \sim 5 \cdot 10^{20} \text{ s}^{-1}$  do not give any disruptions and the "ionisation-condensation" instability gives only oscillations on the plasma edge.

## 6. Deuterium retention and removal

The main reason of recycling decrease is the high growth of sorption of hydrogen species  $\text{D}^+$  and  $\text{H}^+$  on the lithium covered wall. Moreover, helium sorption was discovered in T-11M experiments as well [6,7], but with a slow desorption during 20-100s after discharge. In order to avoid helium sorption it was sufficient to heat the T-11M chamber wall to  $50\text{-}100^\circ\text{C}$ . For deuterium even highest attainable wall temperature  $250\text{-}300^\circ\text{C}$  turned out to be insufficient.



**Fig. 9.** Oscillations of the Li limiter surface temperature and other parameters caused by the instability at the plasma edge in the discharge with a Li limiter at high temperature  $\sim 600^\circ\text{C}$ .



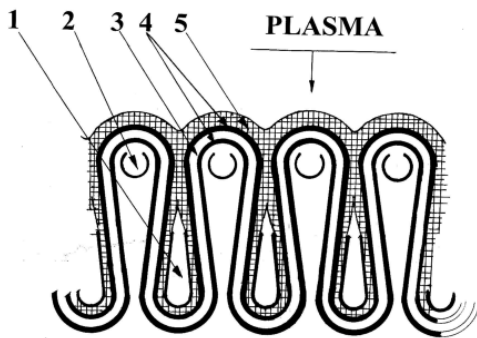
**Fig. 10.** The evolution of plasma radiative loss profile in the discharge with a "hot" Li limiter, temperature  $\sim 580^\circ\text{C}$ . Development of "ionisation-condensation" instability.

However the Li-limiter heating up to 450°C after plasma experiments shown a start of deuterium desorption from lithium at temperatures higher than 320°C [7,8]. Lithium hydrides are supposed to be decomposed at temperatures higher than 600°C. Therefore, one may conclude that considerable part of deuterium wasn't captured by lithium in the form of deuteride, but it was just dissolved in lithium. As it was shown later in USA[12] and Japan [13] investigations by direct heating of lithium to 400-500°C seems to be sufficient to desorb all deuterium and, probably, tritium also. The difference of helium and deuterium desorption temperatures may be used for helium and hydrogen isotopes separation in reactor.

### 7. The lithium CPS shielding for first wall of tokamak-reactor

The ITER project development has shown that considerable difficulties are encountered when actually known engineering solutions and materials are considered for first wall and divertor plates. The Li capillary-pore system seems today as real candidate for reactor PFC. Evaporated Li will carry out the role of a gas target and will smooth a thermal load by lithium radiation. The TFTR experience of lithium injection into the hot plasma showed that it is favorable for plasma confinement and contributes to the decrease of  $Z_{\text{eff}}(0)$  down to a reactor level  $\sim 1.2-1.5$  [11]. Unfortunately, the cooling circuit of first wall and divertor seems to be a serious problem for Li-reactor. Incompatibility of Li and water requires unusual solutions. For example, it can be suggested the organic coolers (difenil, for instance [7]) or water double circuit system with intermediate heat conductor. The some version of such wall is presented in Fig. 11. Its main features are: a thin CPS layer (5), Li- channel (1), the steel double bellows (4) with thickness  $\approx 2\text{mm}$  and intermediate gap  $\approx 0,3\text{mm}$ , filled by He (3) or Ga, tubes of water cooling (2).

This divided gap should work as heat conductor between two bellows. Internal bellows contacts with CPS and Li. The external one contact with water. The simple calculation shows, that if the Li temperature will be 450°C and water 200 °C, the density of passing heat flux should be equal to 0.4 MW/m<sup>2</sup>. The heat flux can be increased to 2MW/m<sup>2</sup>, if the gap will be filled by Ga. These fluxes seem to be good enough for first wall, but not so good for ITER like divertor. That means, that the tendency of smoothing of heat flux between divertor and wall will be useful for Li- tokamak concept.



*Fig.11. Double first wall with a water cooling.*

### 8. Summary

1. Lithium, as lowZ material, is compatible with plasma of small and large tokamaks (TFTR, T-11M, CDXU).

2. The surface tension forces in CPS may be used to solve the problem of pondero-motive forces (splashing suppress) and regeneration problem of PFC.

3. Experiments with hydrogen (deuterium) and helium plasmas on T-11M tokamak with Li – CPS limiter have shown:

-No spontaneous bursts of lithium ejection under heat flux to limiter at the level about 10 MW/m<sup>2</sup> have been observed.

- Total lithium erosion is close to level of hydrogen and lithium ions sputtering.

- The lithium radiation protected the limiter from high power load during disruptions.
- The solid basis of CPS limiter had no damages after more than  $2 \cdot 10^3$  of plasma shots.
- The recovery temperature of hydrogen isotopes from Li is 320-500°C (for helium 50-100°C). Therefore, at high PFC temperatures (400<sup>0</sup>-500<sup>0</sup> C) a tritium capture can be minimized.
- It should be provided, that separation of helium and hydrogen isotopes will be possible in lithium circuit with lower PFC temperatures.

4. These results are making a convincing basis for the advance of the liquid lithium PFC for steady state Li-tokamak. The following problems of such tokamak might be decided: wall and divertor plates erosion, "dust" accumulation and redeposition, tritium recovery, low  $Z_{\text{eff}}(0)$ , heat removal during steady state and disruptions.

We assume, the lithium tokamak will be the next step toward DEMO-reactor.

## References

- [1] UWMAK-I. A Wisconsin Toroidal Fusion Reactor Design Study, (UWFDM-68, University of Wisconsin, 1974).
- [2] EVTIKHIN V.A., GOLUBCHIKOV L.G., "Divertor of fusion reactor", RF Patent 2051430, Feb. 7, 1995.
- [3] EVTIKHIN V.A. et al, "The liquid lithium fusion reactor", Proc. 16<sup>th</sup> Int. Conf. on Fusion Energy, Montreal, 7-11 Oct. 1996. Fusion Energy 1997, IAEA, Vienna 3 659 (1997).
- [4] LAZAREV V.B. et al, "Compatibility of the lithium capillary limiter with plasma in T-11", Proc. 26<sup>th</sup> EPS Conf. on Contr. Fusion Plasma Phys., ECA, **231**, 845 (1999).
- [5] EVTIKHIN V.A. et al, Experimental Study of the Tokamak plasma interaction with Lithium Capillary-Porous Systems ", 18<sup>th</sup> IAEA FEC, 2000, Sorrento, Italy, Exp 4/21.
- [6] EVTIKHIN V.A. et al, "Technology Aspects Of Lithium Capillary-pore Systems Application In Tokamak Device", SOFT-21 (Madrid), A-37.
- [7] EVTIKHIN V.A. et al, "Lithium divertor concept and result of supporting experiments" Plasma Phys. and Contr. Fusion **44** 955 (2002).
- [8] MIRNOV S.V. et al, "Li-CPS limiter in tokamak T-11M" Fusion Eng. Des. **65** 455 (2003)
- [9] ALLAIN J.P. et al, "Measurements and modeling of D, He and Li sputtering of liquid lithium", J. Nucl. Mater. **290-293** (2001) 180, Nucl. Fusion, **42**(2002), 202.
- [10] MAJESKI R. et al, "Liquid Lithium wall experiments in CDX-U", 18<sup>th</sup> IAEA FEC 2000, Sorrento, Italy, Book of abstracts, p.102.
- [11] MANSFIELD D.K., et al, "Observations Concerning the Injection of a Lithium Aerosol into the Edge of TFTR Discharges", Preprint PPPL-3526, December 2000.
- [12] BALDWIN M.J. et al, "Deuterium in molten lithium: retention and release". 43 Annual Meeting of APS, Division of Plasma Phys. Rep. Nr CP1 25.
- [13] FURUYAMA Y. et al, "Characteristics of lithium thin films under deuterium ion implantation" J. Nucl. Mat. **313-316** 288 (2003).
- [14] ROGNLIEN T.D, RENSINK M.E., "Interactions between liquid-vapor and edge plasmas", Journal of Nuclear Materials, **290-293** 312 (2001).
- [15] LAZAREV V.B. et al, Quasi-stationary tokamak experiment with thin liquid lithium limiter, 30<sup>th</sup> EPS Conference on Contr. Fusion and Plasma Phys., St. Petersburg, 7-11 July 2003 ECA Vol. 27A, P-3.162.
- [16] EVTIKHIN V.A. et al, Plasma Science & Technology, vol.6, №3, 2292-2295, 2004.
- [17] LAZAREV V.B. et al, "Peculiarities of Radiative Loss Profiles and Radiation-Condensation Instability in the T-11M Tokamak Discharges with Lithium Limiter", 31<sup>th</sup> EPS Conference on Contr. Fusion and Plasma Phys., London, July 2004, P4.152.